



**HAL**  
open science

# IMPROVING THERMODYNAMIC RETRIEVALS FROM IASI DATA USING REALISTIC OZONE AND OZONE-SENSITIVE CHANNELS

Olivier Coopmann, Vincent Guidard, Nadia Fourrié, Matthieu Plu

► **To cite this version:**

Olivier Coopmann, Vincent Guidard, Nadia Fourrié, Matthieu Plu. IMPROVING THERMODYNAMIC RETRIEVALS FROM IASI DATA USING REALISTIC OZONE AND OZONE-SENSITIVE CHANNELS. 2016 EUMETSAT Meteorological Satellite Conference, EUMETSAT, Sep 2016, DARMSTADT, Germany. meteo-01399168

**HAL Id: meteo-01399168**

**<https://meteofrance.hal.science/meteo-01399168>**

Submitted on 18 Nov 2016

**HAL** is a multi-disciplinary open access archive for the deposit and dissemination of scientific research documents, whether they are published or not. The documents may come from teaching and research institutions in France or abroad, or from public or private research centers.

L'archive ouverte pluridisciplinaire **HAL**, est destinée au dépôt et à la diffusion de documents scientifiques de niveau recherche, publiés ou non, émanant des établissements d'enseignement et de recherche français ou étrangers, des laboratoires publics ou privés.

# IMPROVING THERMODYNAMIC RETRIEVALS FROM IASI DATA USING REALISTIC OZONE AND OZONE-SENSITIVE CHANNELS

Olivier Coopmann, Vincent Guidard, Nadia Fourrié, Matthieu Plu

CNRM – Météo-France & CNRS, 42 avenue Gaspard Coriolis, 31057, Toulouse Cedex, France

## Abstract

Hyperspectral infrared sensors onboard polar-orbiting satellites provides 70% of measures used in the Numerical Weather Prediction (NWP) global model ARPEGE (Action de Recherche Petite Échelle Grande Échelle) of Météo-France, where IASI (Infrared Atmospheric Sounding Interferometer) represents 46%. The infrared passive sounding is sensitive to surface parameters and numerous atmospheric constituents. The atmospheric temperature information is retrieved from the channels which are sensitive to gases the distribution of which is known. Most of algorithms for infrared satellites measures use carbon-dioxyde ( $\text{CO}_2$ ) sensitive channels to retrieve the temperature information. Part of the infrared spectrum are also sensitive to ozone ( $\text{O}_3$ ) but are not currently used in the NWP models of Météo-France. In the current version of the assimilation in the ARPEGE model, the gas concentrations used for the radiance simulations are constant in space and in time. A study conducted in 2015 showed that using realistic ozone information from the Chemistry Transport Model (CTM) MOCAGE (Modèle de Chimie Atmosphérique A Grande Echelle) of Météo-France as input of the radiative transfer model improved the temperature retrievals from the infrared satellite measures. This presentation will describe the channel selection of IASI ozone sensitive channels to improve the retrievals of temperature and humidity profiles in the NWP model. There are several methods to select a set of channels to improve the atmospheric profiles such as the Jacobian and iterative methods (Rabier and Fourrié 2001). In our case, we have used DFS and sum of relative error reduction for temperature and humidity. Several settings of observation error covariance matrix have been evaluated such as the iterative Desroziers methods. We have also used different variances from operational NWP and calculated from the simulations in order to set-up the observation error covariance matrix. Results are very promising with sum of relative error reduction method, especially using the Desroziers technique (Desroziers, 2005).

## INTRODUCTION

Since the first weather satellite launched in 1960, the techniques have significantly evolved with ever more sophisticated instruments. The data from instruments onboard these satellites are used in Numerical Weather Prediction (NWP) for assimilation, with positive impact demonstrated on their forecast performance (Bouttier and Kelly 2001). Hyperspectral infrared sounding instruments, such as the Cross-Track Infrared Sounder (CrIS), the Atmospheric Infrared Sounder (AIRS), and the Infrared Atmospheric Sounding Interferometer (IASI), provide 70% of data used in the NWP global ARPEGE (Action de Recherche Petite Echelle Grande Echelle) in Météo-France. IASI has been jointly developed by the CNES (Centre National d'Etudes Spatiales) and EUMETSAT (European Organisation for the Exploitation of Meteorological Satellites). The first instrument has been launched in 2006 onboard Metop-A satellite and the second onboard Metop-B in 2012. With 8461 channels, its spectrum ranges from 645 to 2760  $\text{cm}^{-1}$  with a spectral sampling of 0.25  $\text{cm}^{-1}$ . IASI provides brightness temperatures at the top of atmosphere. It allows to obtain the indirect information on temperature and humidity profiles but also cloud cover, aerosols, atmospheric chemistry composition like  $\text{O}_3$ ,  $\text{CO}_2$ ,  $\text{CO}$ ,  $\text{CH}_4$ ,  $\text{HNO}_3$  and  $\text{N}_2\text{O}$  (Clerbaux and al. 2009) and surfaces. The goal for retrieval precision is 1K/1km for temperature and 10%/1km for humidity (Cayla, 2001). This temperature retrieval precision is achieved over ocean but there are problems with humidity in the lower atmosphere. One difficulty is the presence of clouds because clouds can be opaque to the infrared radiance. The IASI instrument has a infrared imaging radiometer which allows to coregister the interferometric soundings with the AVHRR (Advanced Very High Resolution Radiometer) radiometer pictures (Saunders and Kriebel,

1988). The research work of A.D. Collard, (2007) has selected parts of IASI spectrum to be used in NWP including channels that are sensitive to chemistry including 15 ozone-sensitive channels. The selection of Collard led to a 300-channel subset to which CNES added 14 channels for monitoring purpose. This subset of 314 channels is monitored at Météo-France and only 123 channels are assimilated (channels sensitive to temperature in the longwave CO<sub>2</sub> band and to water vapour) in operations. A first part is to assess the realism of two ozone informations, a climatology from RTTOV (Radiative Transfer for TOVS (TIROS Operational Vertical Sounder)) and a realistic ozone field from MOCAGE (MOdèle de Chimie Atmosphérique à Grande Echelle) (MOC60L), provided by the French Chemistry Transport Model (CTM) (Sic and al. 2015). These ozone fields were compared to in-situ measurements. The two possible sources of information for ozone have been also used in as input of radiative transfert model and the simulations were compared to real IASI observations. The first question is: Is a realistic ozone a priori information needed for an optimal channel selection? A second part of this study are the explanation of criterion for the channel selection as well as the description of the One Dimensional Variational approach (1DVar). Then a channel selection has been performed using two possible sources of information for ozone with a constant and diagonal observation error covariance matrix and observation error covariance which is diagnosed with the Desroziers method at each step. The second question is: Should we use the 15 ozone channels or extract a subset to improve the thermodynamic profiles? Finally, we quantified improvement of thermodynamic profiles for the study case with additional ozone-sensitive channels.

## 1. DESCRIPTION OF USED DATA

IASI ozone-sensitive channels available in the operational set monitored at Météo-France is between 1014.5 – 1062.5 cm<sup>-1</sup> shown in *Table 1*. We have also evaluated the sensitivity of these channels to temperature and humidity by plotting the temperature and humidity jacobians with respect to pressure for these 15 channels in *Figure 1*. In *Figure 1 (left)* we have temperature Jacobians with respect to pressure for 15 ozone-sensitive with sensitivity in lower troposphere and middle of stratosphere. In *Figure 1 (Centre)*, humidity Jacobians are sensitive in lower troposphere between 1000 and 300 hPa and in *Figure 1 (Right)*, ozone Jacobians are sensitive in lower and middle troposphere. We have also assessed the sensitivity of simulations at different ozone fields and compared the simulated radiance to the measured radiance.

Channel number	Wavenumber [cm <sup>-1</sup> ]	Channel number	Wavenumber [cm <sup>-1</sup> ]
1479	1014.50	1587	1041.50
1509	1022.00	1626	1051.25
1513	1023.00	1639	1054.50
1521	1025.00	1643	1055.50
1536	1028.75	1652	1057.75
1574	1038.25	1658	1059.25
1579	1039.50	1671	1062.50
1585	1014.00		

*Table 1: List of 15 ozone-sensitive channels.*

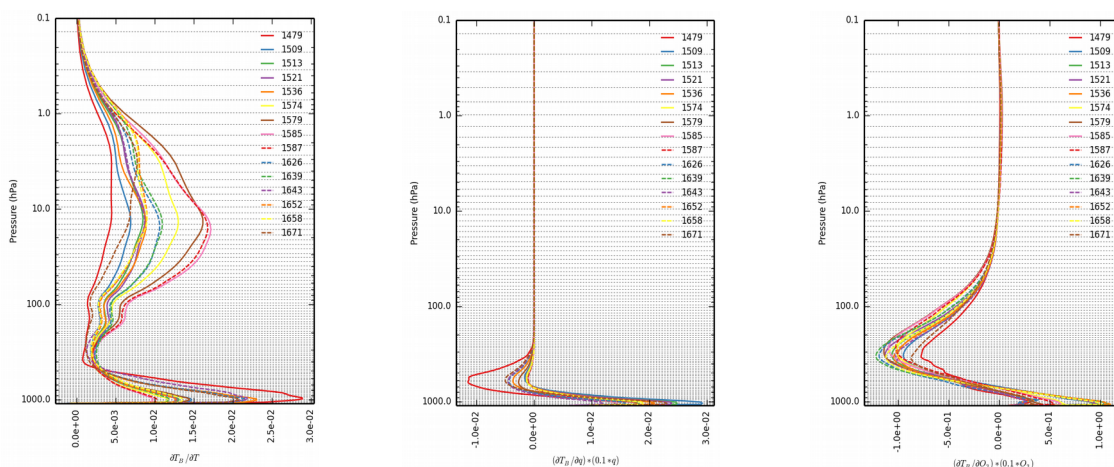

*Figure 1: Temperature (left), Humidity (centre) and ozone (right) Jacobians with respect to pressure for 15 ozone-sensitive channels.*

The two possible sources of information for ozone are a climatology from RTTOV (*Figure 2 left*), constant in time and space with 101 levels up to 0,005 hPa used in operations and a realistic ozone field from MOCAGE (MOC60L) (*Figure 2 right*) with 60 levels up to 0.01 hPa taking into account the sources and sinks in time and space with 2° in global model. The thermodynamic profiles (temperature and humidity) used in this study provided from global NWP model ARPEGE.

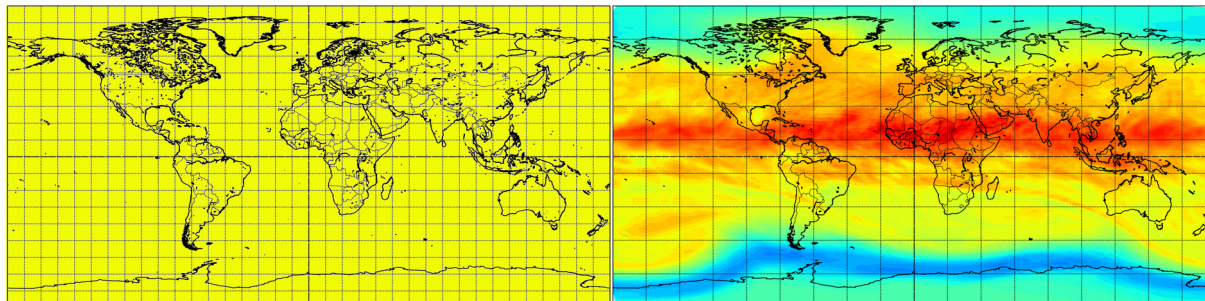

**Figure 2:** Example of ozone field to a particular level pressure for RTTOV (left) and MOC60L (right).

## 2. EVALUATION OF THERMODYNAMIC AND OZONE PROFILES

In this section we will show how we have evaluated the thermodynamic and ozone profiles. We have used radiosondes with temperature, humidity and ozone data from WOUDC, SHADOZ and NOAA/ESRL/GMD networks as verification data. We ended with 45 stations and 1690 profiles covering the Poles, Mid latitudes and Tropics over a one year period from April 2014 to March 2015 (cf *Figure 3*).

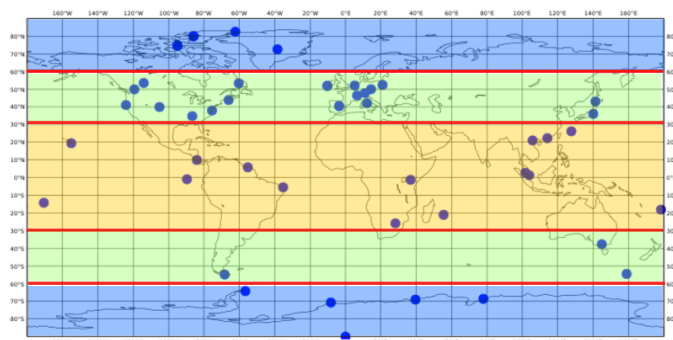

**Figure 3:** Stations from WOUDC, SHADOZ and NOAA/ESRL/GMD used in this study.

To evaluate the thermodynamic profiles, we have computed statistics between temperature and humidity from the global NWP model ARPEGE minus radiosondes for Poles, Mid latitudes and Tropics over the period between April 2014 and March 2015. Average and standard deviation of these statistics are shown in *Figure 4*. We observe low biases for temperature differences between model and radiosonde in *Figure 4. A* but the standard deviations are more important in the Poles (*Figure 4. B*) because of the surface temperature over sea ice which is not well simulated by NWP model yet. However, the next NWP operational version at Météo-France will include SURFEX (Surface Externalized Platform) (Le Moigne and al 2009, Salgado, 2010) and GELATO (Salas-Mélia, 2002) with a better simulation of surface temperature over sea ice. *Figure 4. C* shows biases of humidity differences between model and radiosonde with lower bias for Mid latitudes and Tropics and higher bias for Poles in lower troposphere between 1000 and 250 hPa. However, we have an important bias in Tropics for humidity between 250 and 50 hPa which may be due to the overshoot but also due to bias in the sondes for temperature and humidity from radiative warming more important in the Tropics during the time. As often with humidity, there is a high variability as shown by the standard deviation in *Figure 4. D* for the three bands of latitudes in the troposphere.

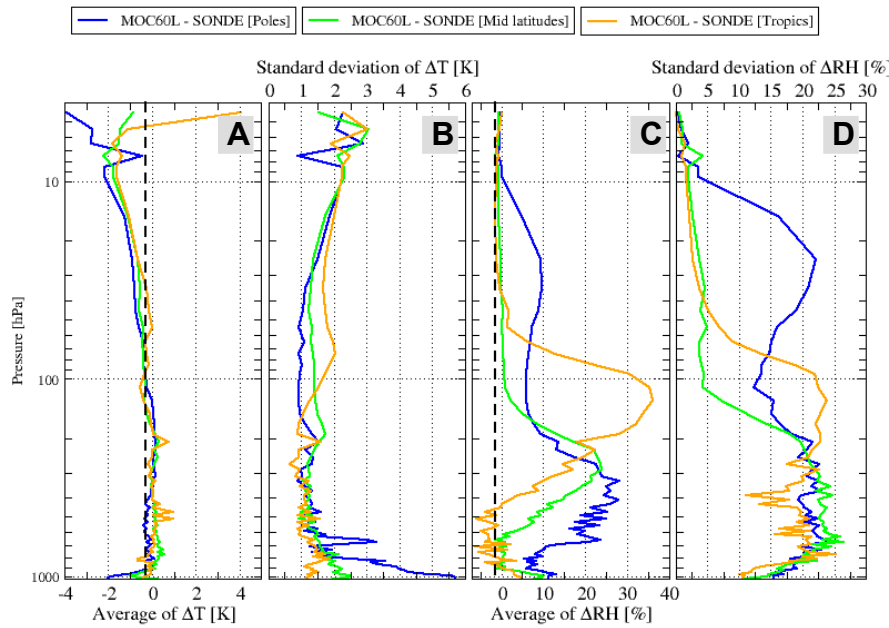

**Figure 4:** (A) Average of  $\Delta T$ , (B) standard deviation of  $\Delta T$ , (C) average of  $\Delta RH$ , (D) standard deviation of  $\Delta RH$  with respect to pressure for Poles (blue), Mid latitudes (green) and Tropics (orange).

In addition, we have also evaluated statistics for ozone information sources between models MOC60L and RTTOV and ozone-sonde over the whole period (April 2014 to March 2015) for Poles, Mid latitudes and Tropics, presented in *Figure 5*.

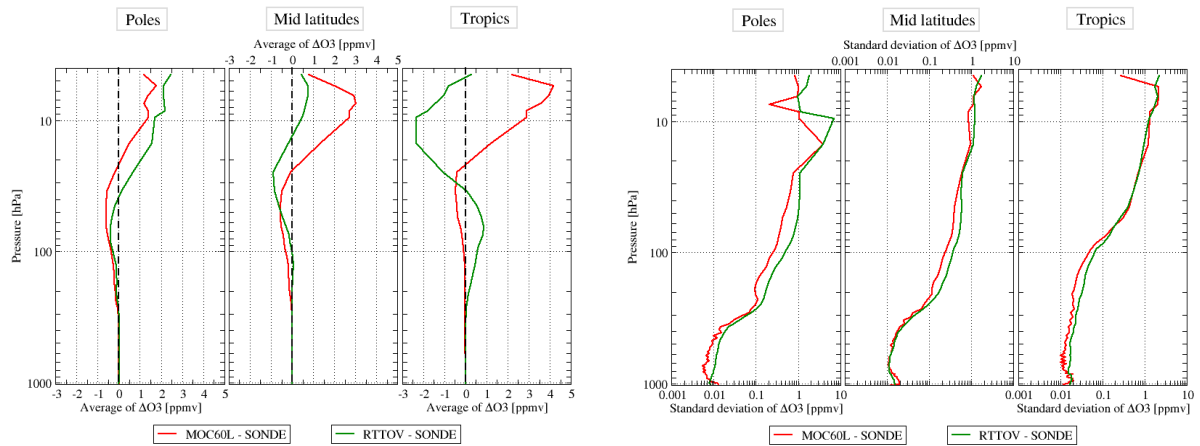
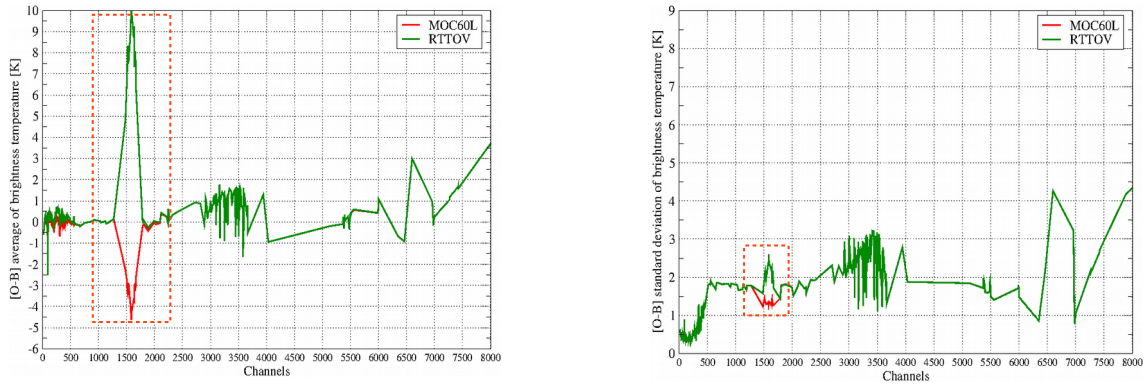

**Figure 5:** Average of  $\Delta O_3$  (left) and standard deviation of  $\Delta O_3$  (right) for ozone difference (MOC60L minus SONDE) with respect to pressure in red and (RTTOV minus SONDE) in green for Poles, Mid latitudes and Tropics.

*Figure 5 (left)* show bias of ozone difference for MOC60L and RTTOV compared to radiosondes. We observed similar aspect of bias for Poles and Mid latitudes with larger bias for RTTOV in Poles and for MOC60L in Mid latitudes with a global trend towards to minimize the ozone fields between 200 and 30 hPa and overestimate the ozone fields above 20 hPa.

However, in the Tropics we observe an opposite trend for the ozone informations from MOC60L and RTTOV. When MOC60L underestimates the ozone fields, RTTOV overestimates this between 200 and 30 hPa whereas below 200 hPa it is the reverse. This best simulation of ozone for MOC60L is reflected by better results for standard deviation showed in *Figure 5 (right)* whatever the latitude band.

### 3. IMPACT OF THE OZONE INFORMATION ON THE SIMULATIONS



**Figure 6:** Average of  $\Delta T_B$  (left) and standard deviation of  $\Delta T_B$  (right) for the differences between real observations and simulations from MOC60L (red) and RTTOV (green) ozone for IASI channels in the Tropics (operational 314 subset) with 63 clear pixels over sea for the whole period of this study.

A set of pixels from the IASI instrument have been collocated with radiosondes around the globe for the whole period of this study. The two possible sources of information for ozone have been used in the radiative transfert model. In order to evaluate their accuracy, the simulations were compared to real IASI observations. We have only selected the clear pixels over sea with orthodromic distance between radiosonde and pixels less than 150 km and a temporal variation less than one hour. We have selected 42 pixels in Poles, 71 in Mid latitudes (not shown) and 63 in Tropics to compute statistics between simulations and observations in *Figure 6*. The ozone band is between  $1014.50 \text{ cm}^{-1}$  and  $1062.50 \text{ cm}^{-1}$ , in the 314 channel subset used at Météo-France. The *Figure 5 (left)* shows biases which will be subtracted to observations for next data used in 1DVar (bias-correction). The lower standard deviations for MOC60L show that the ozone from MOCAGE is more realistic than the one from RTTOV. Which also corroborates the previous results in *Figure 5*.

### 4. 1DVAR AND CHANNEL SELECTIONS

The goal of this study is to select the IASI ozone sensitive channels that have a positive impact on the retrievals of temperature and humidity profiles, depending on each ozone information. Two 1DVAR methods have been used for the channel selection with operational observation errors  $\sigma_{\text{ope}}$  and errors derived from the difference between simulation and observations calculated previously  $\sigma_{\text{simul}}$ . The first method is a 1DVAR with a constant and diagonal observation error covariance matrix  $R_{\text{diag}}$ . The second method uses observation error covariance matrix which is diagnosed (Desroziers method) at each step  $R_{\text{iter}}$  (*Figure 7*) in order to take into account correlations between each ozone channels. We have used two criteria: the DFS (Degree of Freedom for the Signal) and the sum of relative error REDuction (RED) for temperature and humidity. The DFS is not appropriate for our study because we used too few channels to be able to estimate the stop of the selection. The RED criterion is calculated with  $r_i$  retrieval,  $b_i$  background and  $s_i$  sonde, at each vertical level  $i$ ,  $n$  the number of vertical levels (54 for temperature and 29 for humidity), such as:

$$RED = \sum_{i=1}^n \left[ \frac{sd(r_i - s_i) - sd(b_i - s_i)}{sd(b_i - s_i)} \right]$$

Several settings of observation error covariance matrix have been evaluated such as  $R_{\text{iter}}$  computed with the iterative Desroziers method (Desroziers et al, 2005), with  $da^0$  residual and  $db^0$  innovation:

$$R_{\text{iter}} = E \left[ \begin{matrix} d^0 \\ a \\ b \end{matrix} (d^0)^T \right]$$

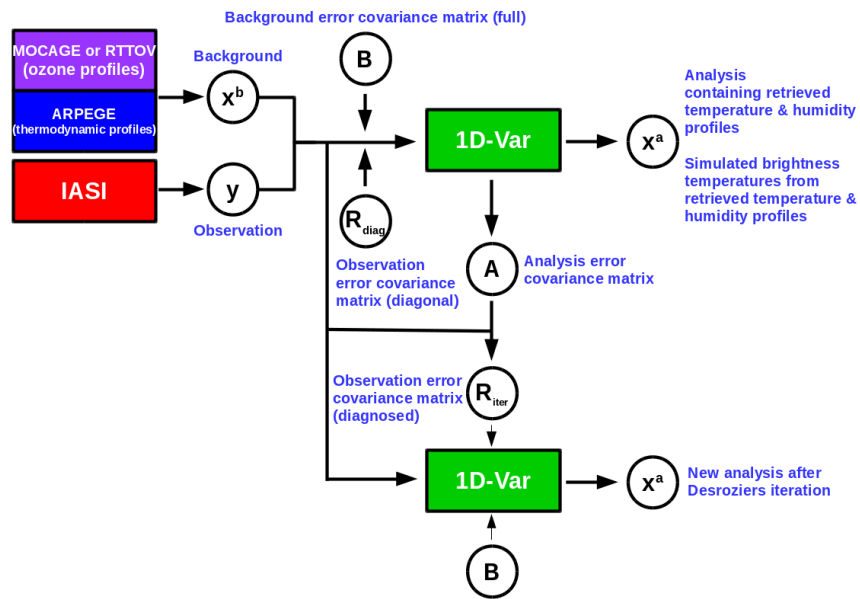

Figure 7: Scheme of 1DVAR iterative Desroziers method.

An example is shown for the selection with  $R_{iter}$  and  $\sigma_{simul}$  with MOC60L in Tropics for a sonde at Paramaribo (Suriname) on 2014/10/22 which illustrates an improvement of humidity especially between 300 and 700 hPa when adding only four O3 sensitive channels in Figure 8 (left). These results are linked to the overall relative error reduction for temperature and humidity in Figure 8 (right).

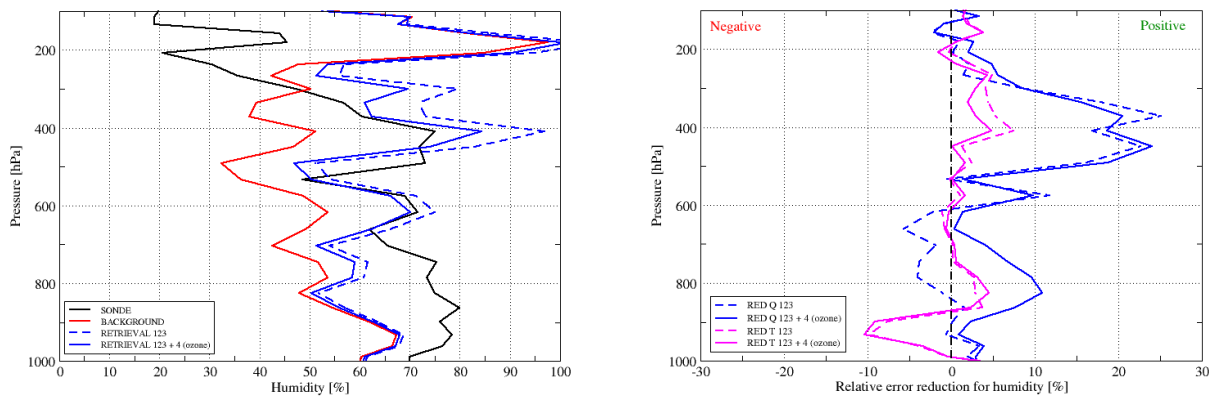
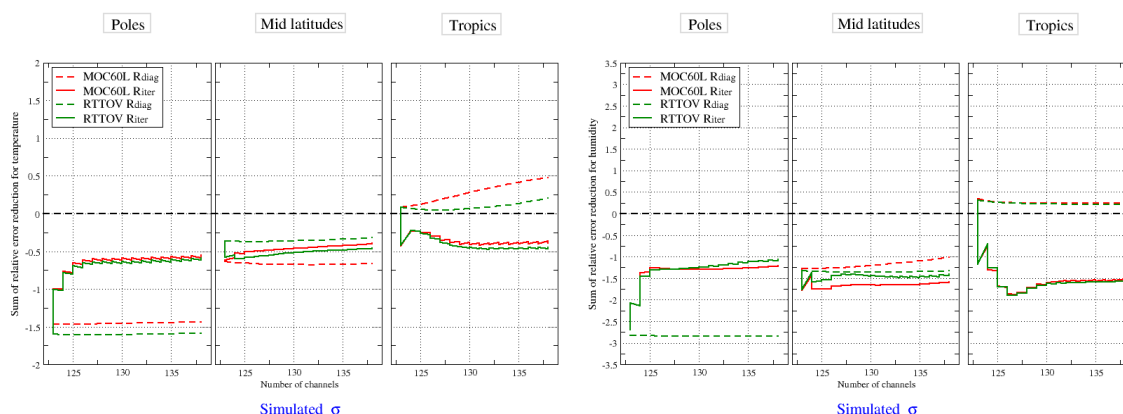

Figure 8: Example of retrieval improvement for humidity profile in Tropics (Paramaribo 2014/10/22) with  $R_{iter}$  selection and  $\sigma_{simul}$  for MOC60L (left) and relative error reduction for temperature (pink) and humidity (blue) with only 123 operational channel (dashed) and four ozone sensitive channels in addition (plain) (right).

A channel selection has been performed with  $R_{diag}$  and  $R_{iter}$  with each source of information for ozone. The error reduction is equivalent using  $\sigma_{ope}$  and  $\sigma_{simul}$  for the selection with  $R_{iter}$  but it is better with  $\sigma_{simul}$  for  $R_{diag}$  selection (Figure 9). We can see better results with  $R_{iter}$  mainly for Mid latitudes and Tropics for the reduction of temperature and humidity. In Poles, selection with  $R_{iter}$  is slightly degraded but we show a point of convergence and stabilisation around -0.5 for temperature and -1.5 for humidity. It seems that using the 15 ozone channels with these settings leads to an improvement of temperature and humidity profiles in all regions, including humidity in the Tropics where it is known to be difficult to have an improvement in NWP.



**Figure 9:** Sum of relative error reduction (RED) with respect to additional 15 ozone sensitive channels for temperature (left) and humidity (right) for MOC60L (red) and RTTOV (green) with  $R_{diag}$  (dashed) and  $R_{iter}$  (plain).

The analysis of observations errors explains this degradation over Poles for channels selection with  $R_{iter}$ . Indeed, the observation errors simulated for Poles are higher than those Mid latitudes and Tropics (Table 2). The higher the value of observation errors, the fewer informations of ozone-sensitive channels are considered. These non optimal observation errors over the Poles can be explained by high values of average and standard deviation for temperature shown in Figure 4.A and 4.B

	Poles		Mid latitudes		Tropics	
$\sigma_{simul}$	Min	Max	Min	Max	Min	Max
<b>MOC60L</b>	3.6	4.3	1.6	2.2	1.2	1.4
<b>RTTOV</b>	3.3	4.2	2.5	3.4	1.6	2.6

**Table 2:** Maximum and minimum of observation errors simulated for MOC60L and RTTOV to Poles, Mid latitudes and Tropics.

## CONCLUSION AND FUTURE WORK

Evaluation of thermodynamic profiles showed important bias and standard deviation for humidity across the globe making it difficult to our NWP models to improve humidity retrievals. Realistic ozone information, such as the one provided by the French CTM MOCAGE, helps to have much better simulation of ozone-sensitive infrared channels such as lower bias and standard deviation for the difference between simulations and real observations for MOC60L compared to RTTOV. A realistic ozone field allows us to have a better variability in time and space and thus to compute observation errors ( $\sigma_{simul}$ ) more consistently. A channel selection has been carried out for each ozone information. Improvements have been obtained on temperature and humidity retrievals especially in Tropics using a full observation error covariance matrix (Desroziers method).

This is a first approach of the coupling between CTM and NWP models and the first results are very encouraging to continue this work and improve our thermodynamic retrievals in our NWP models. The results of this study will allow the ozone channel assimilation at Météo-France. We are now ready to use the new channels selection in the global model ARPEGE. Assimilation experiments will be done with RTTOV ozone profile. The impact of assimilation of ozone sensitive channels will be evaluated on analyses and forecasts. Following this, experiments will be conducted with ozone in the control vector to evaluate their impact on retrievals. The first results are very interesting and will be shown in future paper being written. This paves the way to similar studies with future sensors such as IASI-NG which will have 16921 channels. We will also use other molecules such as  $CO_2$ ,  $CO$ ,  $CH_4$ ,  $NO_2$  and possibly other molecules.



## REFERENCES

- Bouttier, F. and Kelly, G., 2001. Observing-system experiments in the ECMWF 4D-Var data assimilation system. *Quarterly Journal of the Royal Meteorological Society*, 127(574), pp.1469-1488.
- Cayla, F.R., 2001. L'interféromètre IASI-Un nouveau sondeur satellitaire haute résolution.
- Clerbaux, C., Boynard, A., Clarisse, L., George, M., Hadji-Lazaro, J., Herbin, H., Hurtmans, D., Pommier, M., Razavi, A., Turquety, S. and Wespes, C., 2009. Monitoring of atmospheric composition using the thermal infrared IASI/MetOp sounder. *Atmospheric Chemistry and Physics*, 9(16), pp.6041-6054.
- Collard, A.D., 2007. Selection of IASI channels for use in numerical weather prediction. *Quarterly Journal of the Royal Meteorological Society*, 133(629), pp.1977-1991.
- Desroziers, G., Berre, L., Chapnik, B. and Poli, P., 2005. Diagnosis of observation, background and analysis-error statistics in observation space. *Quarterly Journal of the Royal Meteorological Society*, 131(613), pp.3385-3396.
- Le Moigne, P., Boone, A., Calvet, J.C., Decharme, B. and Faroux, S., 2009. SURFEX scientific documentation. *Note de centre (CNRM/GMME), Météo-France, Toulouse, France*.
- Rabier, F.L.O.R.E.N.C.E., Fourrié, N., Chafaï, D. and Prunet, P., 2001. Channel selection methods for infrared atmospheric sounding interferometer radiances. *QJR Meteorol. Soc*, 128, pp.1-15.
- Mélia, D.S., 2002. A global coupled sea ice–ocean model. *Ocean Modelling*, 4(2), pp.137-172.
- Salgado11, R. and Le Moigne, P., 2010. Coupling of the FLake model to the Surfex externalized surface model.
- Saunders, R.W. and Kriebel, K.T., 1988. An improved method for detecting clear sky and cloudy radiances from AVHRR data. *International Journal of Remote Sensing*, 9(1), pp.123-150.
- Sic, B., El Amraoui, L., Marécal, V., Josse, B., Arteta, J., Guth, J., Joly, M. and Hamer, P.D., 2015. Modelling of primary aerosols in the chemical transport model MOCAGE: development and evaluation of aerosol physical parameterizations. *Geoscientific Model Development*, 8(2).